

*D Series shown with Standard Base (D)  
and #1 Classic moldings*

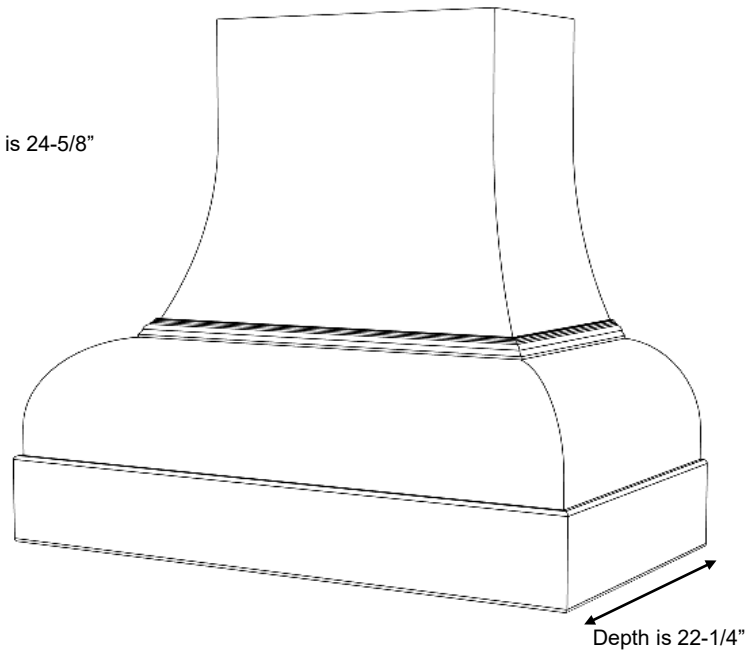

*D Series shown with Hardwood Base (DHW)*

### D Series

Standard Widths	36, 42, 48, 54, 60 (Reduced widths available)
Standard Heights	30, 36, 42, 48 (Reduced heights available)
Removable Options	Not available
Ventilation	Hood will be same width as available vent width. Example: To use a 36" vent model, the hood should be a minimum of 36" wide
Available Moldings	#1 Classic, #2 Simple
Grain Direction	Vertical (Base is horizontal)

Standard Heights: 30, 36, 42, 48

#### D- Standard Base

D 36  
D 42  
D 48  
D 54  
D 60

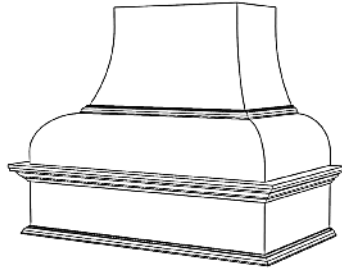

#### D- Hardwood Base

DHW 36  
DHW 42  
DHW 48  
DHW 54  
DHW 60

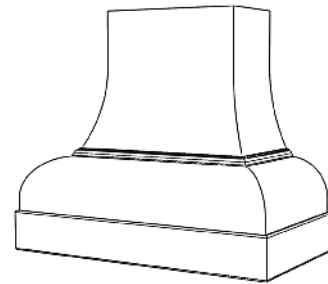

#### D- RS Base

DRS 36  
DRS 42  
DRS 48  
DRS 54  
DRS 60

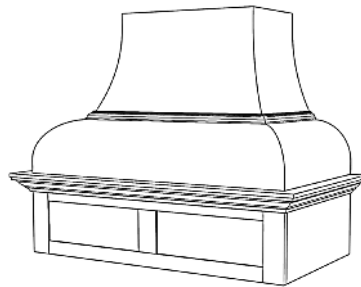

#### D- RSS Base

DRSS 36  
DRSS 42  
DRSS 48  
DRSS 54  
DRSS 60

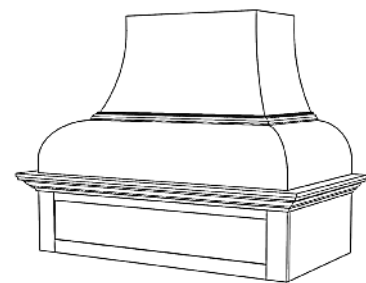

#### D- RA Base

DRA 36  
DRA 42  
DRA 48  
DRA 54  
DRA 60

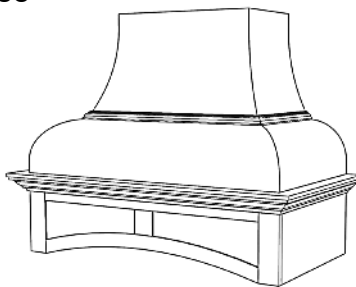

#### D- DP2 Base

DDP2 36  
DDP2 42  
DDP2 48  
DDP2 54  
DDP2 60

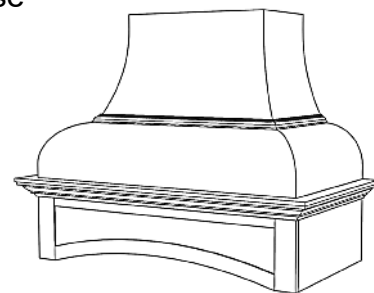

#### D- SL Base

DSL 36  
DSL 42  
DSL 48  
DSL 54  
DSL 60

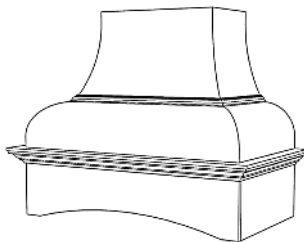

#### D- DP1Base

DDP1 36  
DDP1 42  
DDP1 48  
DDP1 54  
DDP1 60

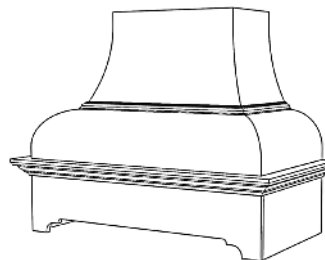

#### D- SS Base

DSS 36  
DSS 42  
DSS 48  
DSS 54  
DSS 60

